

Tamia 180x80

PREDINSTALACIJA
PREDINSTALLACIJA
PREINSTALLATION
VORINSTALLATION

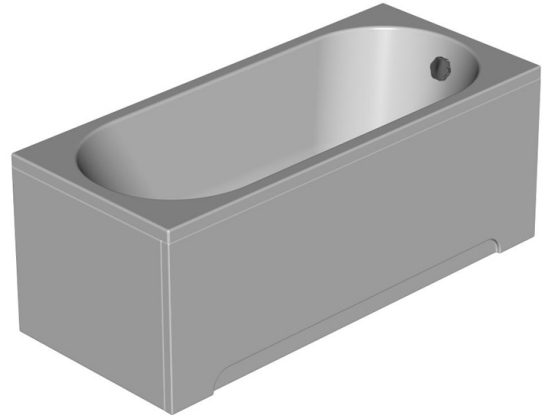
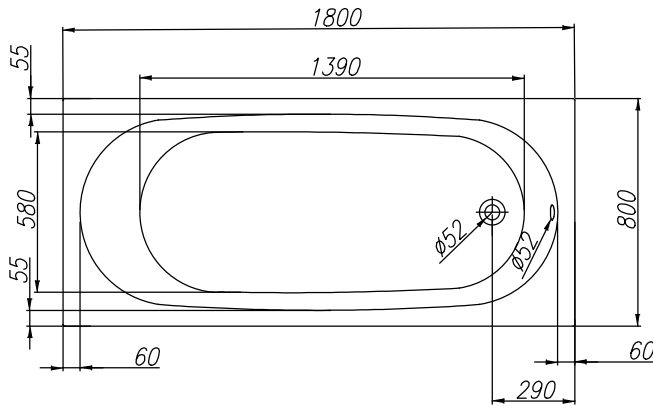
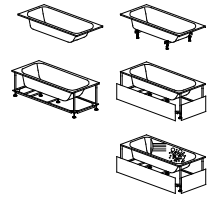
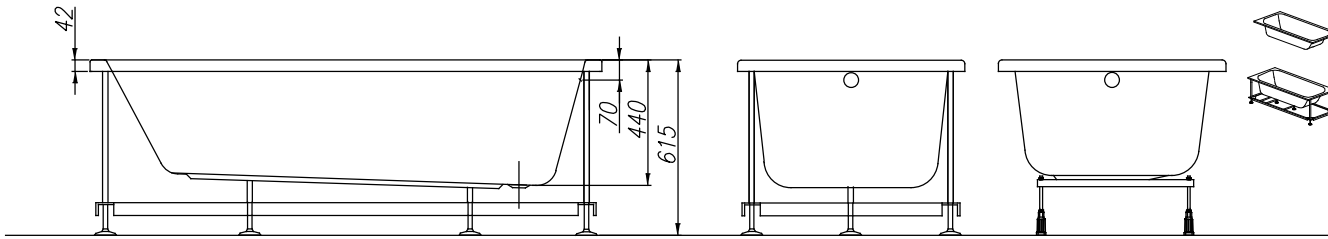

255 L

VOLUMEN
VOLUMEN
VOLUME
VOLUMEN

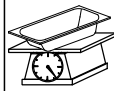

28 kg

TEŽA
TEŽINA
WEIGHT
GEWICHT

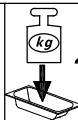

400 kg

MAX. OBREMENITEV
MAX. OBTEREČENJE
MAX. LOAD
MAX. BELASTUNG

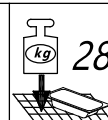

280 kg/m²

OBREMENITEV TAL
OBTEREČENJE PODA
FLOOR LOAD
BODENBELASTUNG



- Prostor za električni vodnik 3x2,5 mm², dolžine pribl. 1 m
- Mjesto za električni vodnik 3x2,5 mm², dužine cca. 1 m
- Spot for electrical cable 3x2,5 mm², length approx. 1 m
- Platz Stromkabel 3x2,5 mm², Länge ungefähr 1 m



- Prostor za električni vodnik 1x6 mm² za ozemljitev, dolžine pribl. 1,5 m
- Mjesto za električni vodnik 1x6 mm² za ozemljenje, dužine cca. 1,5 m
- Spot for electrical cable 1x6 mm² for earthing, length approx. 1.5 m
- Platz Stromkabel 1x6 mm² für Erdung, Länge ungefähr 1,5 m



- Priklop tople in hladne vode 1/2", min 0,2 Mpa, max 0,4 Mpa
- Priključak tople i hladne vode 1/2", min 0,2 Mpa, max 0,4 Mpa
- Connection of hot and cold water 1/2", min 0.2Mpa, max 0.4Mpa
- Anschluss Warm- und Kaltwasser 1/2", min 0,2 Mpa, max 0,4 Mpa



- Prostor za odtok Ø 50 mm
- Mjesto za odtok Ø 50 mm
- Drain spot Ø 50mm
- Abflussplatz Ø 50 mm



- Opcija - obloga
- Opcija - obloga
- Option - panel
- Möglichkeit - Schürze

priporočilo za vgradnjo
preporuka za ugradnju
installation recommendation
Einbauempfehlung

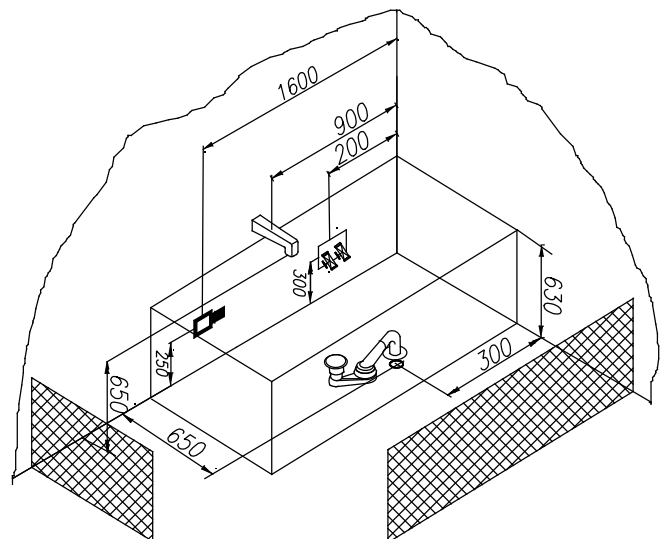

Priporočena prelivna garnitura
Preporuka prelivne garniture
Recommended overflow set
Vorgeschlagene Überlaufgarnitur

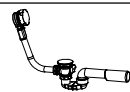

PAL 450

kopalna kad brez oblog - navodilo za vgradnjo
Kada bez obloge - upute za ugradnju
Bathtub without panel - installation instructions
Badewanne ohne Schürze - Einbauanleitung

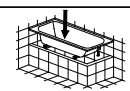

Nr. MK 03

Opcija podnožja za kadi brez obloge
Varianta postolja za kade bez obloge
Option of the built-in bathtub base
Möglichkeit des Sockels für die Badewannen ohne Schürze

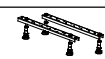

Nr. MK 05
PKK 501

Kopalna kad z oblogo - navodilo za vgradnjo
Kada s oblogom - upute za ugradnju
Bathtub with panel - installation instructions
Badewanne mit Schürze - Einbauanleitung

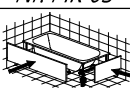

Nr. MK 01

Opcija podnožja za kadi z oblogo
Varianta postolja za kade sa oblogom
Option of the bathtub base with panel
Möglichkeit des Sockels für die Badewannen mit Schürze

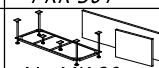

Nr. MK 20
SET 180x80







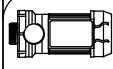

TAMIA 180x80

V NAVEDENO KOPALNO KAD NE VGRAJUJEMO ARMATUR ZA POLNENJE KADI
 U NAVEDENU KUPAONSKU KADU NE UGRADJUJEMO ARMATURE ZA PUNJENJE KADE
 WE DO NOT INSTALL TUB FILLING FITTINGS IN THE GIVEN BATHTUB
 WIR INSTALLIEREN KEINE WANNENFÜLLSTÜTZE IN DIE ANGEGEBENE BADEWANNE

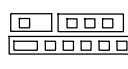
2/2

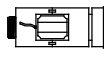
TAMIA 180x80

POLOŽAJ STIKAL IN AGREGATOV PRI RAZLIČNIH IZVEDBAH MASAŽNIH SISTEMOV
 MJESTO PREKIDAČA I AGREGATA KOT RAZLIČITI IZVEDBI MASAŽNIH SISTEMA
 POSITION OF SWITCHES AND GENERATORS IN DIFFERENT VERSIONS OF MASSAGE SYSTEMS
 POSITION SCHALTER UND AGGREGATE BEI VERSCHIEDENEN AUSFÜHRUNGEN VON MASSAGESYSTEMEN

	<ul style="list-style-type: none"> - VODNA ČRPALKA - CRPKA ZA VODU - PUMP - WASSERPUMPE 		<ul style="list-style-type: none"> - VODNE ŠOBE - VODENE MLAZNICE - WATER JETS - WASSERDÜSEN 		<ul style="list-style-type: none"> - REGULATOR ZRAKA - REGULATOR ZRAKA - AIR CONTROLLER - LUFTREGLER 		<ul style="list-style-type: none"> - ELEKTRONSKA STIKALA - ELEKTRONSKI PREKIDAČI - ELECTRONIC SWITCHES - ELEKTROSCHALTER 		<ul style="list-style-type: none"> - ARMATURA IN TUŠ ROČICA - PIPA I TUŠ - FIXTURE AND SHOWER HANDLE - WASSERHAHN UND DUSCHE
	<ul style="list-style-type: none"> - ZRAČNI KOMPRESOR - ZRAČNI KOMPRESOR - BLOWER - LUFTPUMPE 		<ul style="list-style-type: none"> - ZRAČNA ŠOBA - ZRAČNA MLAZNICA - AIR JET - LUFTDÜSE 		<ul style="list-style-type: none"> - PNEVMATSKO STIKALO - PNEVMATSKI PREKIDAČ - PNEUMATIC SWITCH - PNEUMATIKSCHALTER 		<ul style="list-style-type: none"> - LUČ ALI CHROMOTERAPIJA - SVJETLO ILI CHROMOTERAPIJA - LIGHT OR CHROMOTHERAPY - LICHT ODER CHROMOTHERAPIE 		<ul style="list-style-type: none"> - PREKLOPNIK ZA MIKROŠOBE - PREKIDAČ ZA MIKROMLAZNICE - MICROJET SWITCH - SCHALTER FÜR MIKRODÜSEN

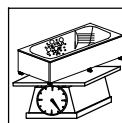

TEŽA
TEŽINA
WEIGHT
GEWICHT
 59 kg

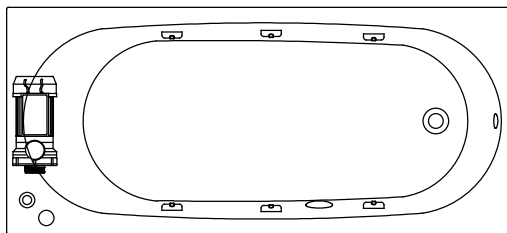

VODNI MASAŽNI SISTEM 1

- VODNA ČRPALKA P= 800W
- PNEVMATSKO STIKALO
- REGULATOR ZRAKA
- 6 VODNIH ŠOB

VODENI MASAŽNI SISTEM 1

- CRPKA ZA VODU P= 800W
- PNEVMATSKI PREKIDAČ
- REGULATOR ZRAKA
- 6 MLAZNICA ZA VODU

WATER MASSAGE SYSTEM 1

- PUMP P=800W
- PNEUMATIC SWITCH
- AIR CONTROLLER
- 6 WATER JETS

WASSERMASSEGESYSTEM 1

- WASSERPUMPE P = 800 W
- PNEUMATIKSCHALTER
- LUFTREGLER
- 6 WASSERDÜSEN

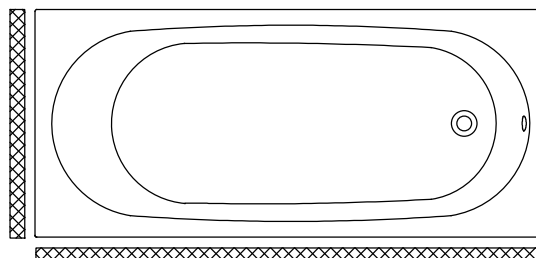

OPCIJE

- POLOŽAJ OBLIG NA KOPALNI KADI

OPCIJE

- POZICJA OBLIGE NA KADI

OPTIONS

- PANEL POSITIONS ON THE BATH

MÖGLICHKEITEN

- POSITION DER SHÜRZE FÜR BADEWANNE